

XR 60

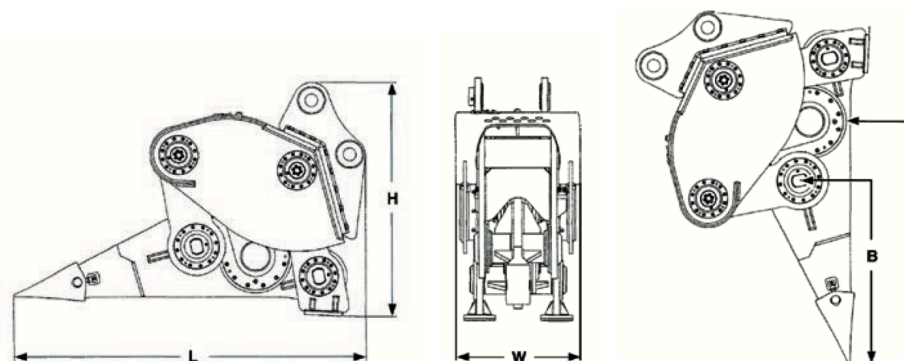

Item		XR 60
Hydraulic excavator	tons	55 - 70
Mass of ripper (incl. top bracket)	kg	7000
Mass of ripper (less top bracket)	kg	5700
Hydraulic working pressure	MPa	26 - 28
Hydraulic return pressure	MPa	0.6
Hydraulic oil flow	L/min	280
Case drain maximum pressure	MPa	0.4
Frequency	1/min	1000
Dimensions L x W x H	cm	345 x 110 x 217
Dimension A	cm	226
Dimension B	cm	176
Accumulator pressure	MPa	0.25



XCENTRIC RIPPER INTERNATIONAL, S.L.

Arriurdina, 15 · 01015 Vitoria-Gasteiz (Spain) · Tel.: +34 945 290 555

www.xcentricripper.com