

XR 50

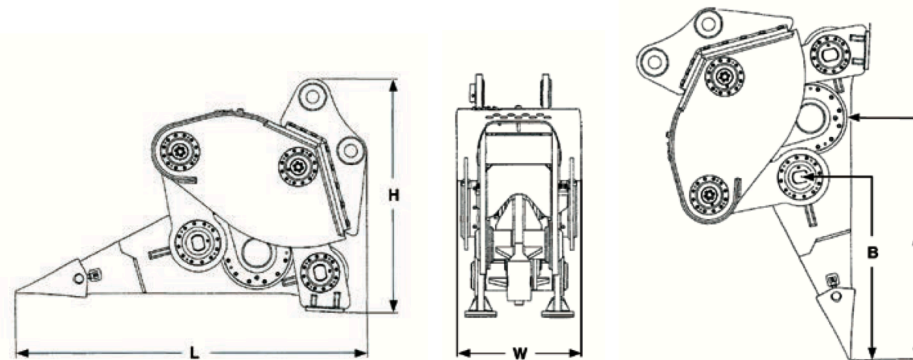

Item		XR 50
Hydraulic excavator	tons	42 - 55
Mass of ripper (incl. top bracket)	kg	5600
Mass of ripper (less top bracket)	kg	5000
Hydraulic working pressure	MPa	26 - 28
Hydraulic return pressure	MPa	0.6
Hydraulic oil flow	L/min	250
Case drain maximum pressure	MPa	0.4
Frequency	1/min	1000
Dimensions L x W x H	cm	320 x 90 x 190
Dimension A	cm	210
Dimension B	cm	165
Accumulator pressure	MPa	0.4



XCENTRIC RIPPER INTERNATIONAL, S.L.

Arriurdina, 15 · 01015 Vitoria-Gasteiz (Spain) · Tel.: +34 945 290 555

www.xcentricripper.com