

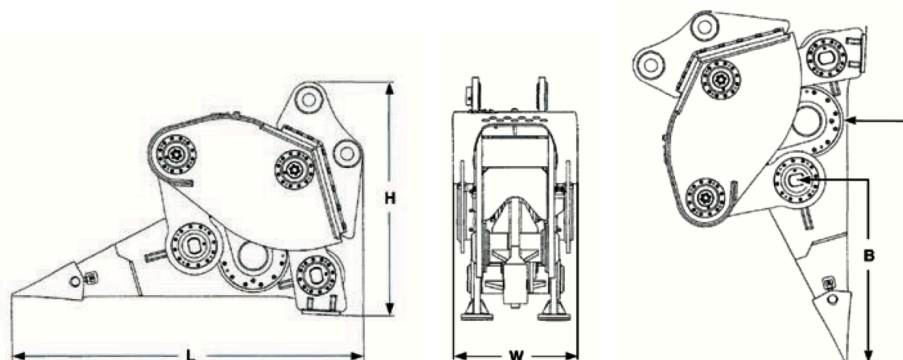

XR 15



Item		XR 15
Hydraulic excavator	tons	11 - 16
Mass of ripper (incl. top bracket)	kg	1700
Mass of ripper (less top bracket)	kg	1550
Hydraulic working pressure	MPa	16 - 19
Hydraulic return pressure	MPa	0.6
Hydraulic oil flow	L/min	120
Case drain maximum pressure	MPa	0.4
Frequency	1/min	1400
Dimensions L x W x H	cm	220 x 66 x 130
Dimension A	cm	140
Dimension B	cm	105
Accumulator pressure	MPa	0.5



XCENTRIC RIPPER INTERNATIONAL, S.L.

Arriurdina, 15 · 01015 Vitoria-Gasteiz (Spain) · Tel.: +34 945 290 555

www.xcentricripper.com